



HECKLER & KOCH

NO COMPROMISE

MP7 A1

GAS AIRSOFT / cal. 6 mm

UMAREX HOLDS THE WORLDWIDE EXCLUSIVE HK-TRADEMARK AND EXTERIOR DESIGN COPY LICENSE FOR USE WITH THIS UMAREX PRODUCT, GRANTED BY HK, INC., U.S.A.



- EN Operating instructions 2 - 10
- FR Mode d'emploi 11 - 19
- ES Manual de instrucciones 20 - 28

⚠ WARNING: NOT A TOY. ADULT SUPERVISION IS REQUIRED. MISUSE MAY CAUSE SERIOUS INJURY, ESPECIALLY TO THE EYE. EYE PROTECTION DESIGNED FOR AIRSOFT GUNS MUST BE WORN BY THE USER AND ANY PERSON WITHIN RANGE. READ THIS OWNER'S MANUAL BEFORE USING. MAY BE DANGEROUS UP TO 220 YARDS (200 METERS).



SAFE GUN HANDLING



DESCRIPTION



OPERATION



CARE



SAFETY INSTRUCTIONS

You should be fully familiar with the proper and safe handling of your airsoft gun. The basic principles of gun safety require you to always apply the following rules when handling an airsoft gun.

- Always handle any gun as if it were loaded.
- Always put the safety of the gun "ON SAFE" when loading it so that there can be no risk of an unintentional discharge.
- Always keep your finger off the trigger and out of the trigger guard until ready to shoot.
- Only use the kind of projectiles specified for your gun.
- Always keep the muzzle pointed in a safe direction.
- Never transport a loaded gun. Only load your gun when you intend to fire it.
- Avoid ricochets. Never fire at smooth, hard surfaces or water.
- Before you discharge your gun, make sure that the target and surrounding area are safe.
- Make sure that you always have full control over the muzzle of your gun, even if you stumble or fall down.
- Safety shooting glasses should always be worn when firing any gun. Shooting glasses must be worn over normal reading glasses.
- Always store your gun in a safe place and in unloaded condition. Unauthorized persons (persons not familiar with the use of guns, children and minors) must not have access to it, ammunition is to be kept in a separate place.
- The gun together with its operating instructions may only be handed over to persons who have reached the age of 18 (or older) and who are fully familiar with the handling of it.
- Modifications or repairs of guns should only be performed by an authorized Umarex USA gunsmith.
- Never leave a loaded gun unattended.
- Only unloaded guns are to be handed over to another person.
- Make sure the gun is unloaded when getting it from storage or from another person.



CAUTION

You must be 18 years or older to purchase this airsoft gun.

Carefully read and understand these instructions before using this airsoft gun. Buyers and users must follow the instructions for the safe use of airsoft guns.

WARNING: DO NOT BRANDISH OR DISPLAY THIS AIRSOFT GUN IN PUBLIC - IT MAY CONFUSE PEOPLE AND MAY BE A CRIME. POLICE AND OTHERS MAY THINK THIS AIRGUN IS A FIREARM. DO NOT CHANGE THE COLORATION AND MARKINGS TO MAKE IT LOOK MORE LIKE A FIREARM. THAT IS DANGEROUS AND MAY BE A CRIME.

WARNING: NEVER ASSUME THAT BECAUSE THE AIRSOFT GUN NO LONGER FIRES A BB AND/OR THE MAGAZINE IS REMOVED FROM THE GRIP FRAME THAT A PLASTIC BB IS NOT LODGED IN THE BARREL. ALWAYS TREAT THE AIRSOFT GUN AS THOUGH IT IS LOADED AND WITH THE SAME RESPECT YOU WOULD A FIREARM.

WARNING: NEVER LEAVE A COCKED OR LOADED AIRSOFT GUN UNATTENDED! YOU SHOULD STORE THIS GUN IN UNLOADED AND DECOCKED CONDITION. PUT THE SAFETY "ON SAFE" AND MAKE CAREFULLY SURE THAT THE BARREL IS CLEAR. KEEP THE GUN AWAY FROM CHILDREN AND PERSONS NOT SKILLED IN THE USE OF ARMS. KEEP GUN AND PROJECTILES SEPARATE FROM EACH OTHER SO THAT UNAUTHORIZED PERSONS HAVE NO ACCESS TO IT.

TECHNICAL DATA

System:	Gas Airsoft
Caliber/Ammo:	cal. 6 mm BB
Energy:	> 1,0 JOULE
Velocity:	370 fps (113 m/s) with 0,20 g BB
barrel length:	8.6 in. (220 mm)
Length:	23.5 in. (384 mm - 595 mm)
Weight:	4.7 lbs. (2130 g)
Magazine capacity:	40 BBs
Dangerous area up to:	220 yds (200 m)





⚠ WARNING: YOU SHOULD MAKE IT A HABIT TO LEAVE THE SAFETY ALWAYS IN THE “ON SAFE” POSITION UNTIL YOU INTEND TO FIRE.

⚠ CAUTION

- Only handle the airsoft gun when it is ON SAFE.
- Always make sure that the muzzle points into a safe direction.



FIRE

SAFE

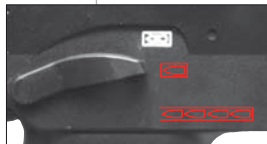

⚠ DANGER: FIRE AND EXPLOSION HAZARD

CONTAINS FLAMMABLE GAS UNDER PRESSURE. WILL BE EASILY IGNITED BY HEAT, SPARKS OR FLAMES. BURNING GAS CAN MAKE CARBON MONOXIDE (CO). CO (CARBON MONOXIDE) IS INVISIBLE, HAS NO SMELL, AND IS LETHAL. GAS CAN MAY EXPLODE WHEN HEATED. RUPTURED GAS CAN MAY ROCKET.

⚠ IMPORTANT:

To reduce chance of fire or explosion:

- Always check gas can and charging adapter valve seal. Do not use if gas can has any unusual dent or rust and/or seal is loose.
- Attach charging adapter outdoors, away from flames or sparks or any other source that could ignite gas.
- Check for leaks in one or more of these ways: Apply soapy water to all connections. LOOK for bubbles, LISTEN for hiss of escaping gas, FEEL for extreme cold, and SMELL for rotten egg odor. If leaking is found, do not use.

⚠ IMPORTANT:

TO USE GREEN GAS:

- Invert gas can and make sure charging adapter is perpendicular to the valve stem of airsoft gun gas reservoir.
- Push can firmly for two or three seconds, pause, repeat. Reservoir is full when you see a little bit of liquid exit the valve.
- For best performance, after charging, allow airsoft gun gas reservoir to reach room temperature before use.

NOTE: Valve misalignment will cause excessive gas leak when charging gas and may result in an inadequate charge.

GREEN GAS HANDLING & STORAGE:

- Keep out of reach of children.
- Do not expose to heat, sparks, or flame.
- Do not leave in direct sunlight.
- Do not store at temperatures above 120°F or below 32°F.
- Never store in living spaces.
- Never refill a green gas canister. Refilling may cause explosion.
- Never put into luggage or take on trains or aircraft.
- Never put in fire or incinerator.
- Do not puncture.



CHARGING OF GAS

EN

⚠ WARNING: KEEP HANDS AND FACE AT A SAFE DISTANCE FROM THE ESCAPING GAS. ESCAPING GAS MAY CAUSE ICING. GAS MAY EXPLODE IF EXPOSED TO TEMPERATURES EXCEEDING 120°F. DO NOT SMOKE, KEEP AWAY FROM OPEN FIRE AND FLAMES. THE GAS IS HIGHLY INFLAMMABLE.

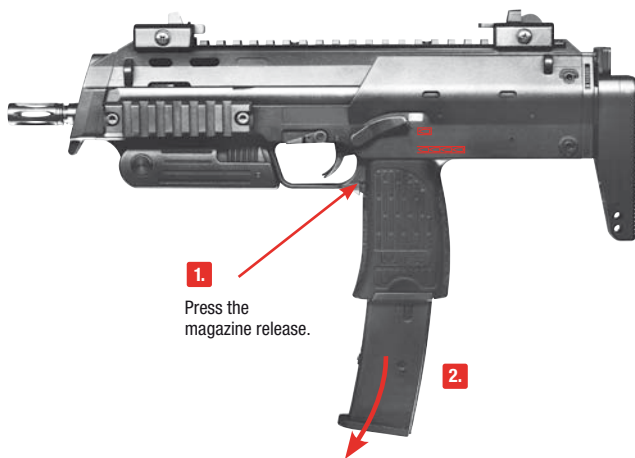

⚠ WARNING: DO NOT INHALE GAS. GAS VAPORS MAY CAUSE DIZZINESS OR ASPHYXIATION WITHOUT WARNING.

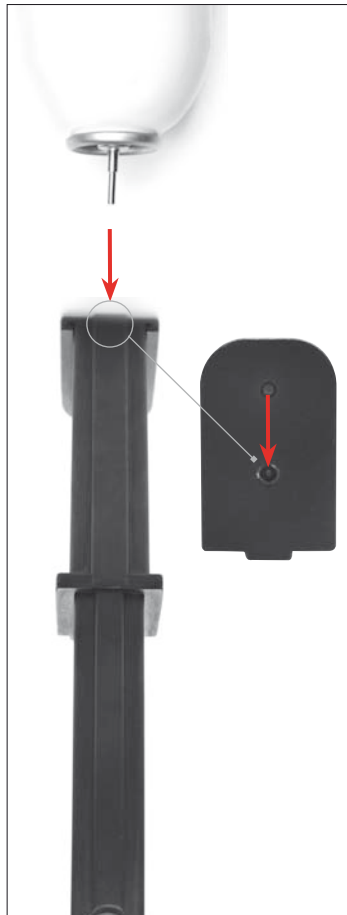

Turn the magazine upside down. Attach the gas flask vertically to the charging port of the magazine. Press the flask against the port. The magazine is fully charged when you observe a discharge of gas from the port.

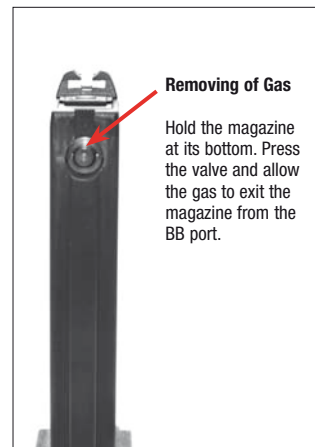

⚠ WARNING: POINT TOP OF MAGAZINE AWAY FROM FACE AND BODY. ESCAPING GAS MAY FREEZE SKIN.



CAUTION



Only use flawless high quality BBs. Never use the following BBs:

① diameter larger than 6mm, ② with edges, ③ both halves not aligned, ④ used, soiled.

Warranty expires if non-recommended BBs are used.

It's recommended to use precision BBs from UMAREX.

To ensure proper operation of the magazine, protect it from dirt and dust.



WARNING: USE .24 CALIBER (6 MM) PLASTIC BBS ONLY IN THIS AIRSOFT GUN. USE OF ANY OTHER AMMUNITION CAN CAUSE INJURY TO YOU OR DAMAGE TO THE AIRSOFT GUN.

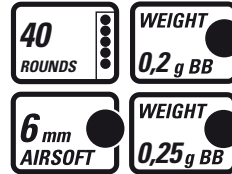

3. Pull down and hold the magazine follower.



ADJUSTABLE SIGHTS



SHOOTING

EN

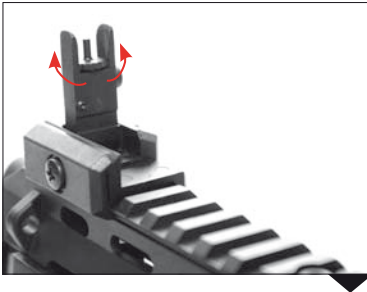

Elevation adjustment

Shoot too high:



Shoot too low:

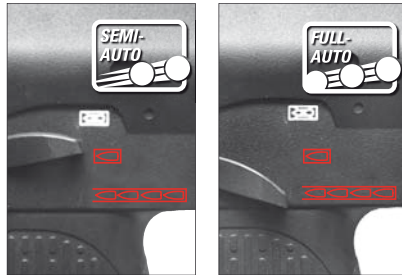

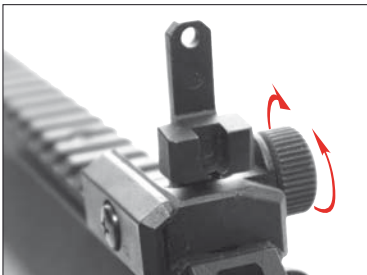

⚠ WARNING: MAKE SURE THAT THE MUZZLE OF THE GUN ALWAYS POINTS INTO A SAFE DIRECTION. NEVER AIM AT PETS OR UNSUSPECTING PERSONS. ALWAYS TREAT YOUR GUN AS IF IT WAS LOADED AND READY TO FIRE.



Windage adjustment

Shoot too far right:



Shoot too far left:

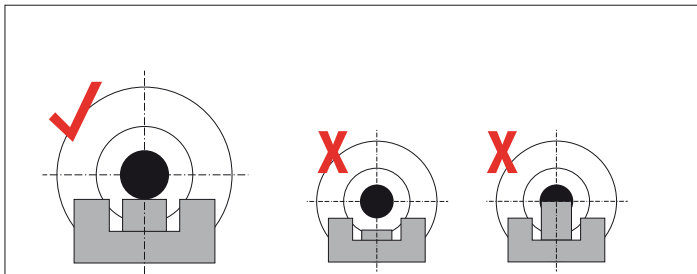
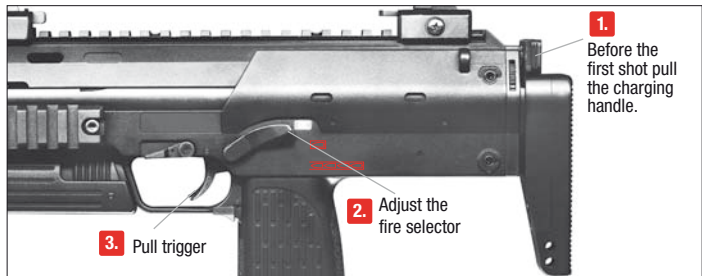





ADJUSTABLE HOP UP

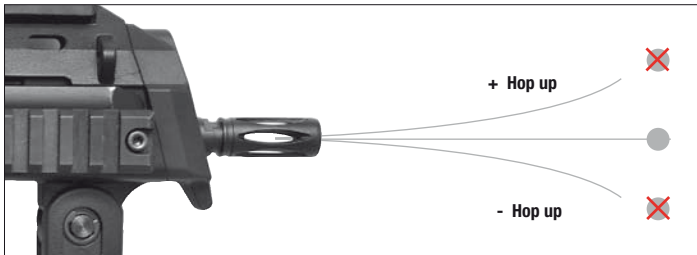
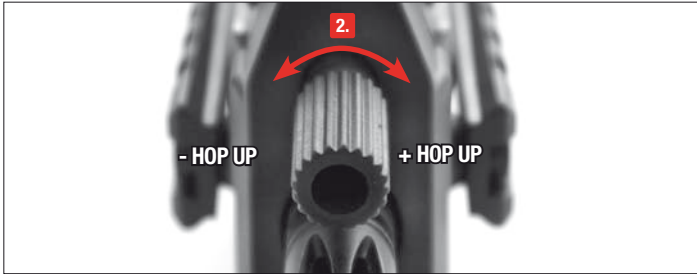
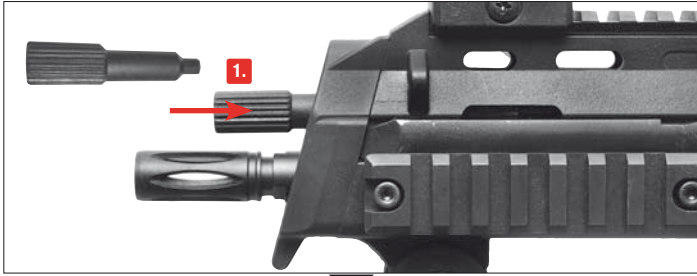

HAND GRIP





Perform routine inspections of the airsoft gun to check for proper operation.

CAUTION

- Adjust the hop up to its normal position before cleaning the airsoft gun.
- Do not force the rod into the barrel, as this could cause damage.
- Never drip silicone oil directly into the barrel.

BARREL CLEANING

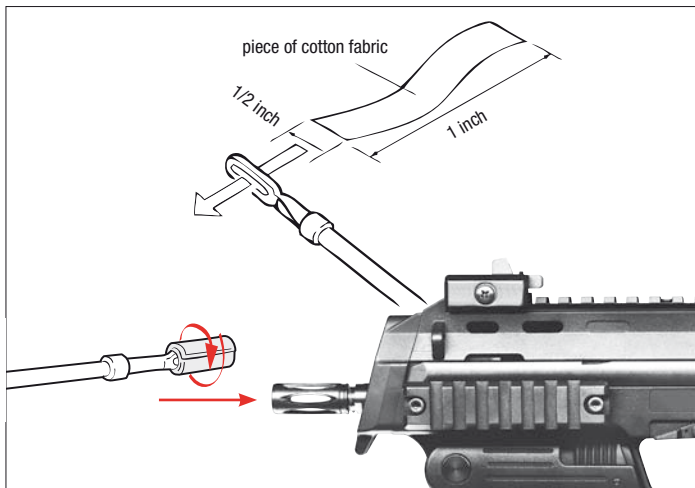

Put the safety ON SAFE and remove the magazine. Prepare a thin rod with a length of approx. 16 inches. Attach a piece of cotton fabric to its end and clean the barrel with some silicone oil.

The exposed metal parts should be wiped clean using a slightly oiled cloth after handling to prevent rust. Use light acid free and resin free oil. RWS Spring Cylinder Oil is excellent for this.

CAUTION

OILS THAT CONTAIN ACID OR RESIN CAN DAMAGE SEALS AND POSSIBLY THE FINISH OF THE STOCK.

Good care and maintenance of the gun will provide you with many years of pleasant shooting.

 WARNING: NEVER ATTEMPT TO CLEAN THE GUN WITHOUT HAVING PUT THE SAFETY ON SAFE FIRST, REMOVE THE MAGAZINE AND CHECK THE BARREL, IT MUST BE CLEAR.

WARRANTY

This product is warranted to the retail consumer for one (1) year from date of purchase against defects in material and workmanship and is not transferable.

WHAT IS COVERED Replacement parts and labor.

WHAT IS NOT COVERED Shipping charges to Umarex USA for defective product and damages caused by abuse or failure to perform normal maintenance as well as any other expense. Consequential damages, or incidental expenses, including damage to property. Some states do not allow the exclusion or limitation of incidental or consequential damages, so the above limitation or exclusion may not apply to you.

WARRANTY CLAIMS Warranty Claims and Repair for U.S. and Canadian customers only. Call Umarex USA (479)-646-4210 and ask for the Service Department. If it is determined a return is necessary, you will be issued a Return Authorization Number. Write this number boldly on the box and return the product prepaid to Umarex USA. Your name, address, phone number and a note explaining the defect found must be included in the package. A copy of the original purchase receipt must accompany the return. Include a check made to Umarex USA in the amount of \$21.95 to cover shipping and handling.

IMPLIED WARRANTIES Any implied warranties, including the implied warranties of merchantability and fitness for a particular purpose, are limited in duration to one (1) year from date of retail purchase. Some states do not allow limitations on how long an implied warranty lasts, so the above limitations may not apply to you. To the extent any provision of this warranty is prohibited by federal, state, or municipal law which cannot be preempted, it shall not be applicable. This warranty gives you specific legal rights, and you may also have other rights which vary from state to state and country to country.

REPAIR

Perform routine inspection and maintenance to check for proper function. Modification may cause a gun to malfunction and tampering with a gun may make it unsafe to use. Any change in the performance, such as lowered trigger force and shortened trigger travel, indicates possible wear and that such guns should be inspected, replaced, or properly repaired, and repairs should only be made by a qualified UMAREX service center. Check any gun that has been dropped to ensure that its function has not been affected.

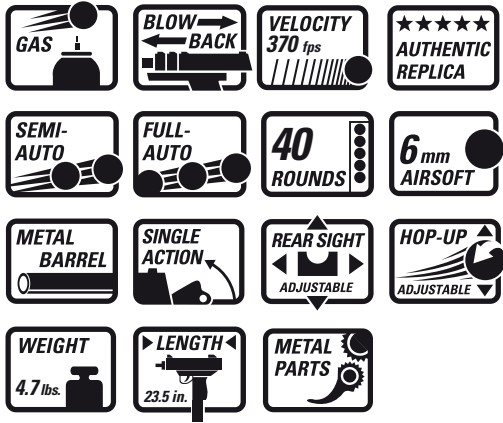

Distributed by / Distribué par:
UMAREXUSA®
www.UmarexUSA.com

6007 South 29th Street
Fort Smith, AR 72908
Phone: 479-646-4210

We reserve the right to make color and design changes and technical improvements. No responsibility is accepted for printing errors or incorrect information.

Sauf modifications de la couleur et du design ainsi que des améliorations techniques, erreurs d'impression et erreur. Toutes les données sont fournies sans garantie.

Salvo modificaciones de color y de diseño así como mejoramientos técnicos, erratas y error. Todos los datos sin garantía.

© UMAREX Sportwaffen GmbH & Co. KG